



White Paper
October 2016



QNAP Enterprise Storage

All-flash Solution for 500 VDI seats

with VMware Horizon View



Notices

The QNAP Enterprise Storage NAS is hereafter referred to as the ES1640dc or QNAP ES.

Legal Notices

All the features, functionality, and other product specifications are subject to change without prior notice or obligation. Information contained herein is subject to change without notice. QNAP and the QNAP logo are trademarks of QNAP Systems, Inc. All other brands and product names referred to are trademarks of their respective holders. Further, the ® or ™ symbols are not used in the text.

Disclaimer

Information in this document is provided in connection with QNAP® products. No license, express or implied, by estoppels or otherwise, to any intellectual property rights is granted by this document. Except as provided in QNAP's terms and conditions of sale for such products, QNAP Assumes no liability whatsoever, and QNAP disclaims any express or implied warranty, relating to sale and/or use of QNAP products including liability or warranties relating to fitness for a particular purpose, merchantability, or infringement of any patent, copyright or other intellectual property right.



Table of Contents

1. Executive summary	5
2. Introduction	6
3. QNAP ES: Benefits and key findings for VDI	7
3.1. ZFS	7
3.2. Dual controller architecture	7
3.3. All-flash solution	8
3.4. Data reduction	8
3.5. Data protection	8
3.6. Cache acceleration	8
3.7. VAAI support	9
3.8. Unified storage	9
4. Test environment	10
4.1. Software	10
4.1.1. VMware vSphere 6	10
4.1.2. VMware Horizon View 6	11
4.1.3. Login VSI	12
4.1.4. Virtual Servers Infrastructure	12
4.1.5. Virtual desktops	13
4.2. Storage architecture	14
4.2.1. Storage pools	14
4.2.2. iSCSI LUNs	14
4.2.3. Storage Layout	15
4.2.4. Configured storage capacity	16
4.3. Hardware and software configuration detailed	17
4.4. Important statements for the tested environment	18
5. Test methodology	19
5.1. Test objectives	19
5.2. Virtual Machine deployment	19
5.3. Login VSI testing	20
5.3.1. Workloads	20
5.3.2. Benchmark mode	21
5.3.3. Testing details	22
5.4. Monitoring tools	22



5.4.1. QES Resource Monitor	22
5.4.2. ESXTOP.....	22
5.4.3. vCenter Performance Monitor.....	23
6. Test results	24
6.1. Login VSI test report.....	24
6.2. Logon, Steady-state and Logoff performance	25
6.3. Deployment and booting performance.....	28
6.4. Storage capacity reduction.....	32
7. Conclusion	34

Table of Figures

Figure 1: QNAP Enterprise Storage - ES1640dc.....	7
Figure 2: Tested VDI environment	10
Figure 3: Horizon View Architecture with QNAP ES	12
Figure 4: Linked Clones Overview.....	13
Figure 5: Storage layout.....	15
Figure 6: VSImax knowledgeworker v4 - Not reached.....	25
Figure 7: Average CPU utilization per server	26
Figure 8: Cluster CPU utilization.....	26
Figure 9: Average disk latency per server	27
Figure 10: ES Storage IOPS.....	28
Figure 11: ES Storage CPU.....	28
Figure 12: IOPS per server when deploying 500VMs.....	29
Figure 13: Disk latency per server when deploying 500VMs	29
Figure 14: IOPS per server when booting 500VMs	30
Figure 15: Disk latency per server when booting 500VMs.....	30
Figure 16: IOPS (cluster) - VDI production cycle.....	31
Figure 17: IOPS % ratio (cluster) - VDI production cycle.....	31
Figure 18: Allocated capacity before virtual machines deployment.....	32
Figure 19: Allocated capacity after virtual machines deployment.....	32
Figure 20: Allocated capacity comparison.....	32
Figure 21: Used capacity after reductions techniques	33



1. Executive summary

This paper provides detailed storage architecture references and testing results for the deployment of 500 VDI users using QNAP ES1640dc. The storage array was filled with SSDs grouped as one storage pool and attached to the hypervisor server using 10Gbps iSCSI. The solution uses a persistent-desktop VDI deployment with VMware Horizon View 6 and linked clones.

During the test for this solution, deploying and booting all 500 desktops at the same time showed the high performance of the QNAP ES single controller, finishing the deployment task in one hour, and booting in less than 7 minutes. From a capacity perspective, after creating the desktops only 290GB of allocated storage was observed in the pool, this is possible because of the ZFS file system and a combinations of storage techniques (thin provisioning, overprovisioning, compression and inline deduplication) that save up to 99% of the capacity for VDI environments.

The performance test was conducted using Login VSI (www.loginvsi.com). Login VSI is the industry-standard load testing solution for centralized virtualized desktop environments. Login VSI is used as workload generator and tests system scalability, performance and availability for the steady-state operation of virtual desktops. Test results reveal that when using a single controller there is still sufficient resources to run additional desktops; if the second controller is considered, the QNAP ES will double the performance and the desktop density will dramatically increase.



2. Introduction

Desktop Virtualization has been steadily growing in the IT industry for the past decade and has quickly become one of the top priorities for companies. Over the next five years, the market for virtualized desktops is projected to experience a compound annual growth rate over 50%, and it shows no signs of slowing down.

The success of a virtual desktop infrastructure (VDI) environment is dependent on user experience, with storage being the area that has the principal impact on users. A poor desktop user experience tends to be translated into bad storage design caused by limited IOPS and high disk latency on the storage array, even if other elements (such as computing power and network speed) play an important role in the whole environment.

The major management concerns for storage in VDI environments are periods of peak usage during the highest storage I/O times. Boot storms are the main cause of I/O spikes. They occur when a large number of virtual desktops all boot up during a short period of time, causing intense concentrated storage I/O that can easily overpower a storage array. Boot storms are read intensive and increase the total IOPS up to 80% of the original VDI equation, which is used in designing write intensive (and very random) steady-state workload. Login storms, logoff storms, virus scans, patching and updating virtual desktops also generate intense IOPS that are a challenge for storage administrators.

With the enterprise-aimed ES1640dc, QNAP provides a storage solution capable of dealing with resource-demanding VDI-like applications, while also offering the best data protection and resilience leveraged by a ZFS-based operating system. By using either an all-flash solution or a hybrid solution with SSD caching, concerns raised by boot storms and other I/O-intensive operations should be minimized when planning and designing VDI solutions on QNAP ES.



3. QNAP ES: Benefits and key findings for VDI

The ES1640dc is whole-new product line developed by QNAP for mission-critical tasks and intensive virtualization applications. With Intel Xeon E5 processors, dual active controllers, ZFS, and the full support of virtualization environments, the ES1640dc delivers “real business-class” cloud computing data storage. The ES1640dc features the brand-new QES operating system that allows almost limitless snapshots, block-level data deduplication, and thin provisioning with reclaim, assisting businesses in building the most cost-efficient VDI platform and storage for critical data.



Figure 1: QNAP Enterprise Storage - ES1640dc

3.1. ZFS

The ES1640dc features ZFS, a combined file system and logical volume manager, to support various advanced functions for high-end enterprise storage, including powerful storage expansion, flexible storage pools, simplified management, high-performance SSD cache, nearly limitless snapshots and cloning, data deduplication, in-line compression and thin provisioning with reclaim for optimized utilization for virtual machine storage.

3.2. Dual controller architecture

The ES1640dc adopts dual active-active controllers to provide the most reliable base for business IT storage. During the VDI solutions test, one single controller was used to handle a heavy workload from 500 VMs, while the second controller managed the data center (virtual servers) of VMware vSphere and Horizon View infrastructure.



3.3. All-flash solution

QNAP ES empowers the most demanding applications by enabling the use of an all-flash solution. Applications like VDI are the best usage scenario of all-flash storage. The VDI IO pattern changes during the production cycle (working day) and unpredictable IO behavior from different users are a real stress-test for storage. No matter the workload set on the QNAP ES, it will be controlled without concerns. Note that even when the first four drives are used for the QNAP system and cache, it is also possible to integrate them into an all-flash storage solution, increasing capacity and performance.

3.4. Data reduction

There could be over 90% duplicate data from OS images and applications that are spread over virtual desktops. The ES1640dc supports block-based data deduplication to optimize storage usage from redundant data. Deduplicated virtual desktops become easier to be cached to achieve optimal virtual desktop performance. In-line data compression helps shrink data size, further optimizing storage usage. For mastering storage in a virtualized environment, the ES1640dc provides businesses with the most cost-effective remote virtual desktop platform and mission-critical information warehousing

3.5. Data protection

ZFS is designed with a focus on data integrity, and uses its end-to-end checksums to detect and correct silent data corruption caused by hardware defects, bugs in firmware or metadata errors, effectively protecting user's data. In ZFS every write is a full-stripe write, and combined with the copy-on-write mechanisms it completely eliminates the RAID "write-hole", a common issue presented on standard storage controller architecture.

3.6. Cache acceleration

The QNAP ES offers cache acceleration to achieve intensive read and write IO operations. SSDs configured for the QNAP system can also be configured as a read cache to boost the IO performance capabilities when working with hybrid storage solutions. The write cache, on the other hand, is powered by 16GB DIMM per controller, increasing the random write performance. This volatile cached data is protected by NVRAM and mSATA SSD modules.



3.7. VAAI support

QNAP ES supports VMware VAAI, enabling the use of iSCSI storage primitives to improve the communication between the hypervisor and the storage array. VAAI increases performance by offloading server loading for ESXi servers to the array, freeing up computing power resources and maximizing the power of the virtual machines. During the whole production cycle of VDI, the VAAI primitives support operations such as:

- Deploying and migrating desktops (XCOPY)
- Powering on the desktops at the same time (ATS)
- Reclaiming unused space from thin-provisioned LUNs (UNMAP)

3.8. Unified storage

QNAP ES offers both block and file based storage (iSCSI LUNS and Share Folders). In VDI environments, when additional capacity is needed for user profiles and data, one of the recommended solutions is to place it in an NFS folder on a regular HDD (providing the best \$/GB ratio) while the desktop OS can be stored on iSCSI LUNs with high-performance SSD drives.

4. Test environment

The overall test environment of the ES1640dc for the VDI solution is presented in this section. The main software and hardware components, including network and hosting are detailed in the following sections.

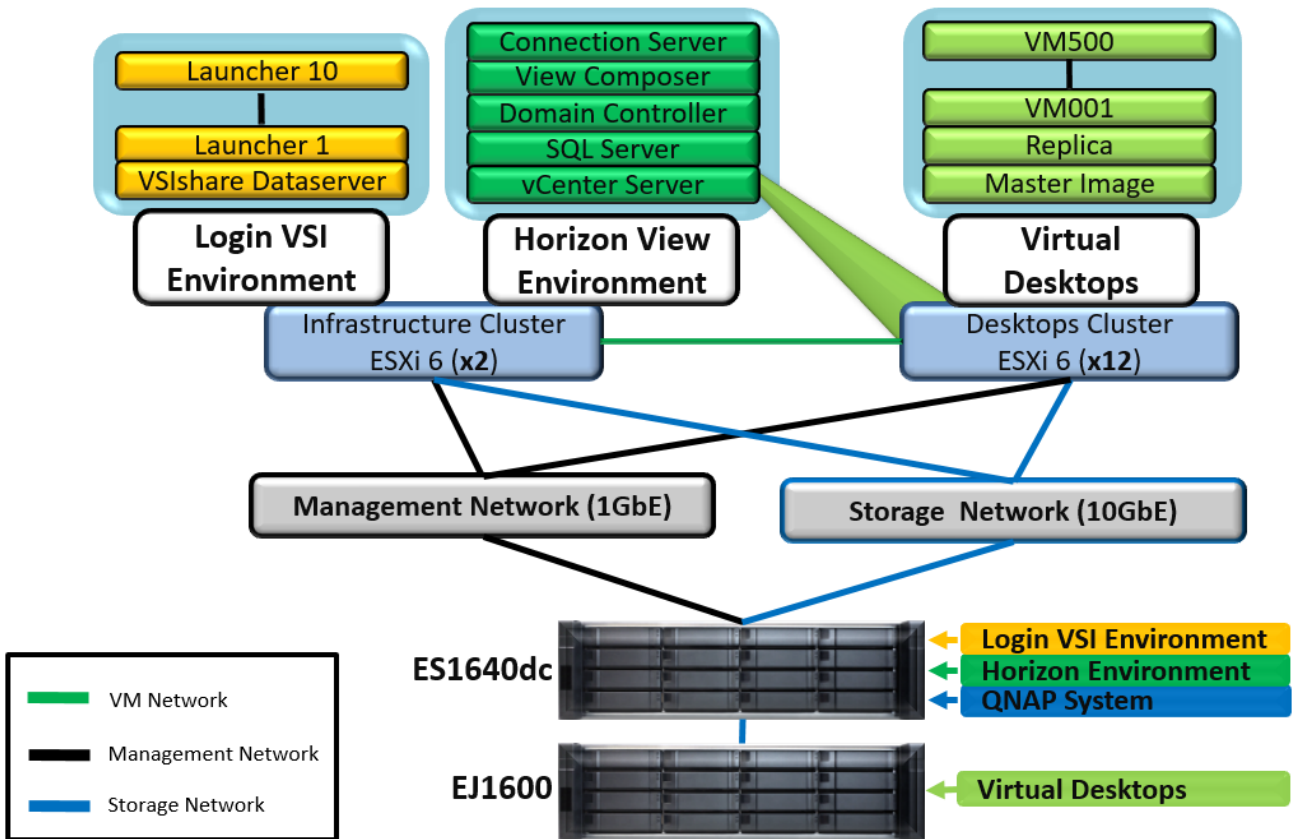

Figure 2: Test VDI environment

4.1. Software

4.1.1. VMware vSphere 6

VMware vSphere 6 is VMware's suite of virtualization products and was used to deploy all the infrastructure environments, including virtual servers and virtual desktop infrastructures for the whole VDI solution. The core components used for VMware vSphere include:



- **VMware ESXi 6:** The Hypervisor and main infrastructure component.
- **VMware vCenter server 6:** For ESXi cluster management and monitoring.
- **VMware vSphere Client 6:** Remote access to vCenter.
- **VMware vSphere Web Client 6:** Remote access to vCenter.
- **Other components like:** VMFS, vSphere vMotion, vSphere Storage vMotion, vSphere DRS and vSphere Storage DRS.

4.1.2. VMware Horizon View 6

VMware Horizon View is the virtual desktop host platform for VMware vSphere that offer advantages for both end users and IT staff. End users are no longer locked to a particular machine and can access their system and files from anywhere at any time. View transforms IT by simplifying and automating desktop and application management.

The core Horizon View components include:

- **View Connection Server:** The most important VMware View component is the View Connection Server. The View Connection Server is a connection broker, and is responsible for authenticating clients and connecting them to the appropriate virtual desktop.
- **View Administrator:** The View Administrator or management console is a web component for deploying and managing virtual desktops.
- **View Client:** Establishes a connection from physical devices to a View Connection Server. View Client is installed on the user's devices (such as: thin clients, zero clients, mobile devices, laptops, desktops or any other devices supported by View Client).
- **View agent:** The application installed on virtual desktops that allows VMware View to manage the access from clients.
- **View Composer:** This is an optional application, but is necessary to manage all of the operations associated with linked clones (such as pool creation, refresh, recompose and rebalance). During this test, View Composer was installed as a standalone independent server.

The components for the Horizon View architecture are presented in Figure 3. The data center environment and storage are also included in the diagram.

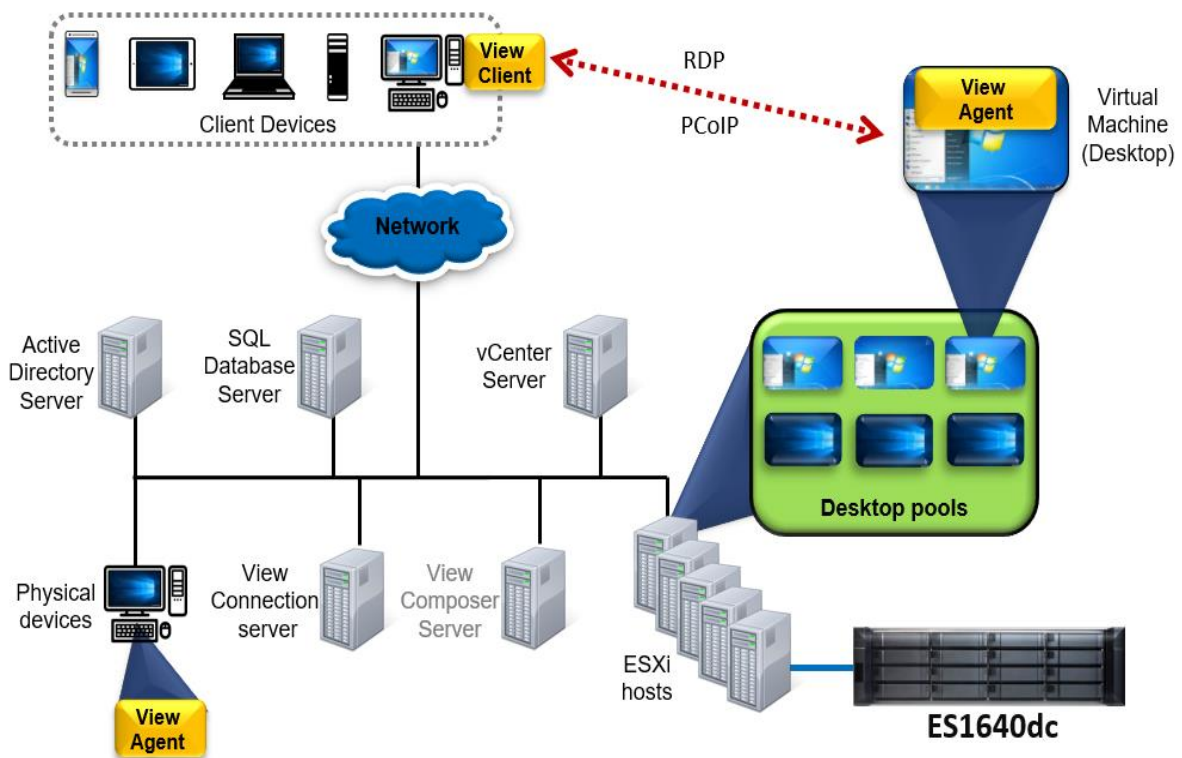

Figure 3: Horizon View Architecture with QNAP ES

4.1.3. Login VSI

Login VSI is the software used to test the desktop performance and scalability on the QNAP ES. Login VSI consists on the following components:

- VSIShare (Datasever)
- Launchers
- Target Environment (VM desktop)
- Microsoft Active Directory

Detailed information about Login VSI is presented in the *Test Methodology* and *Test Results* sections.

4.1.4. Virtual Servers Infrastructure

All the data center, Horizon View and Login VSI infrastructures, were virtualized using VMware vSphere. For all the servers in this infrastructure, Windows Server 2012 R2 was the operating system used to install and manage all the components in the VDI environment. The hardware configuration of these servers is detailed in section 4.3.

The core virtual server for the infrastructures are:

- **Data center:**
 - Active directory with DNS and DHCP service
 - SQL server. Database manager for vCenter, View Composer and View Event Database
 - vCenter server
- **Horizon View:**
 - View Connection server
 - View Composer server
- **Login VSI:**
 - VSIShare (Datasever)
 - Launchers (x10)

4.1.5. Virtual desktops

The virtual desktops were deployed using View Composer Linked Clone. The parent virtual machine (Master Image) used for creating and cloning the desktops was configured with Microsoft Windows 10 and Office 2010. This master image was optimized using Login VSI and Microsoft recommendations. All other required applications were provided by Login VSI and are detailed in section 5.3

The linked clone operation is explained in figure 4. This figure shows the parent VM with the required snapshot for creating the tested desktop pool, which includes the replica and linked clones.

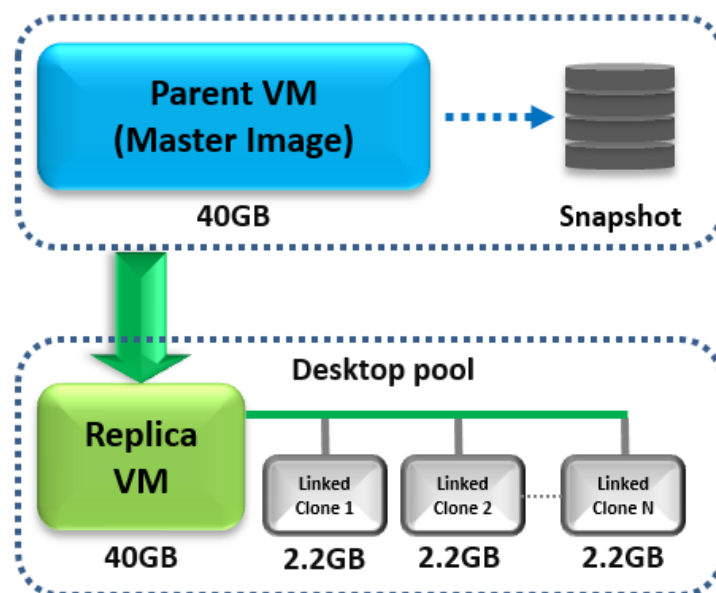

Figure 4: Linked Clones Overview



The parent VM created for the test was configured with 2vCPU, 4GB RAM and 40GB storage (following the references for Windows 10 in VDI environments).

When using full clone to deploy a desktop pool, the total capacity consumed on the ESXi datastores will exceed 20TB. By using linked clones this total storage capacity is drastically reduced to less than 3.2TB (6.2GB per VM) - 84% reduction from the original expected capacity.

Note that each VM is 6.2GB including the 4GB memory swap files, but the real total capacity consumed by all the desktops is only 1.1TB, so the size of each linked clone virtual machine is only 2.2GB.

4.2. Storage architecture

The ES1640dc storage array and the EJ1600 expansion unit (JBOD) were the enclosures used to host the entire VDI environment. It is important to note, the intention of using the expansion unit is to demonstrate the capability of the ES in providing enough performance for the whole solution (servers and desktops infrastructure) and to accommodate the Login VSI application in the same environment.

4.2.1. Storage pools

Two pools were created for the virtual server environments: 6x 120GB SSDs were configured in RAID 6 for each pool. SSDs were used to deliver the highest performance and avoid latency between the servers, Login VSI Dataserver, Launchers and the virtual desktops.

A single storage pool consisting of 16x 240GB SSDs configured in RAID 10 (1.56TB total usable capacity) was configured to manage all the IO operations and capacity for the virtual desktops. All the IO operations and performance of the desktop pool is managed by controller B, while controller A managed the virtual server environment pools (Data center with Horizon View and Login VSI).

4.2.2. iSCSI LUNs

For virtual server environments, one LUN was created for each pool: one to store the data center and Horizon View, and the other to store the Login VSI testing environment.

For the 500 virtual desktops, 6 LUNs were created. Leveraging the creation of desktop pools with linked clones, a separate 500GB LUN was created for the replica to individually analyze its behavior and performance; and 5x 2TB LUNs to store all the virtual machines linked to the replica. Thin-provisioned LUNs were used, so it is possible to use overprovisioning and set the capacity by 90% more of the total available capacity. This capacity overcommit is powered by compression and deduplication technologies. The intention of 2TB LUNs is to provide capacity for growing, storage rebalance operations and space reclamation.

The ES1640dc includes two built-in 10GbE ports per controller that act as iSCSI targets, the LUNs were presented to the ESXi host (Initiator). Six datastores were created, one for each LUN; preserving its original size of 2TB, each datastore allocating about 100 VMs.

4.2.3. Storage Layout

The complete storage layout for the VDI tested environment and summary for the storage architecture section is presented in figure 5.

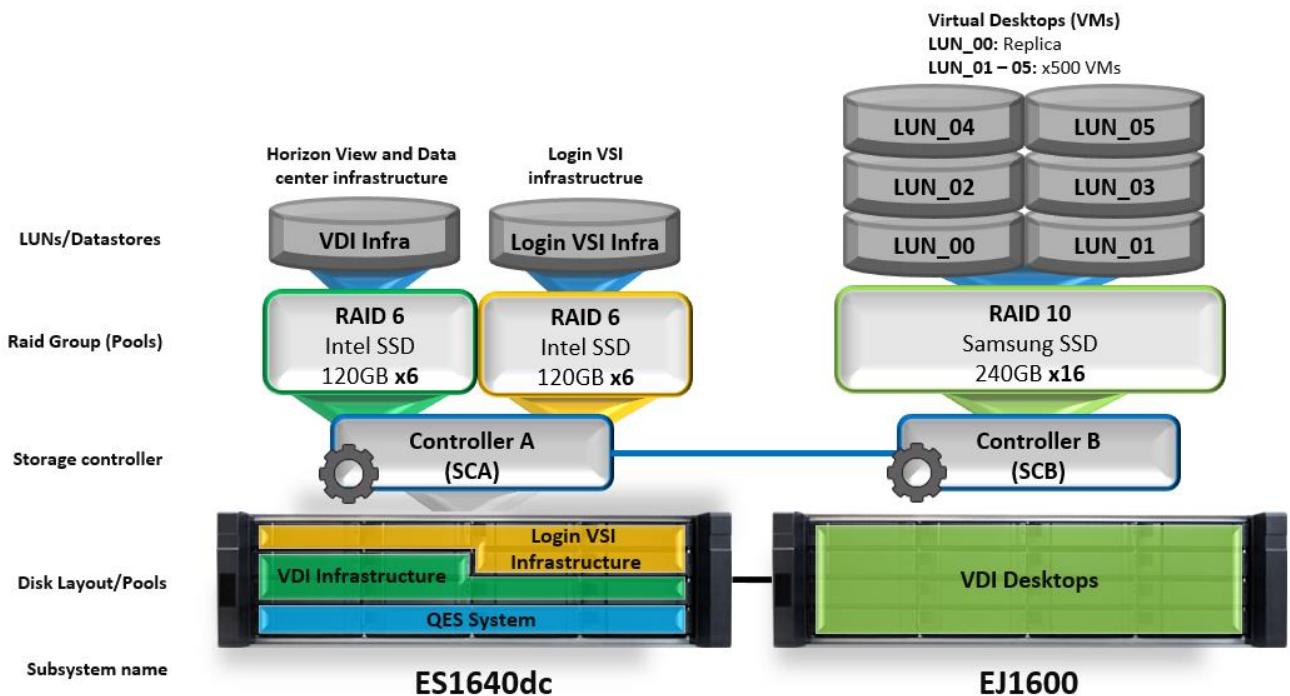

Figure 5: Storage layout



4.2.4. Configured storage capacity

The storage capacity design started with the selection of drives to be used in the enclosure for the virtual desktops. 240GB SSDs were selected to boost the IO performance and decrease the IOPS/\$ ratio at the cost of a reduced storage capacity.

The 240GB is the vendor specification for the SSD capacity, but the real usable capacity per SSD is 223GB (Binary), offering a total capacity of 3.49TB for the 16 SSDs in the enclosure.

Table 1: Storage capacity detailed

Capacity type (On desktop pool)	Size	Description
RAW (Decimal)	3.84 TB	The sum of all drives in the system (TB)
RAW (Binary)	3.49 TB	The sum of all drives in the system (TiB)
Usable	1.56 TB	After RAID configuration and system overhead
Effective	8.8 TB	After compression and deduplication
Configured	10.5 TB	Possible with thin provisioning and overprovisioning

After setting up RAID 10, the usable capacity seen in the pool is 1.56TB.

The effective capacity is the estimation from the compression and deduplication reduction ratio that is 1.2x and 4.7x respectively, and is based on the information collected in the QNAP ES system after several tests.

The configured storage capacity is 10.5TB, which is the capacity calculated to allocate the 500 linked clones and the replica. This capacity is possible in thin provisioned and overprovisioned LUNs created for the storage pool. The overprovisioning was carefully planned based on the behavior of the linked clones in the environment to prevent storage shortages.



4.3. Hardware and software configuration detailed

Table 2: Hardware and software configuration

Environment	Application	System / configuration	Hardware
VDI Infrastructure (Data center and Horizon view)	Active Directory with DHCP and DNS service	Windows 2012 R2 / 4 CPU, 8GB RAM	Intel-based server: Intel Xeon CPU E5-2620 v3 @ 2.40GHz 12 CPUs x 2.399 GHz Memory: 256 GB Network: 2x 1GbE / 2x 10GbE
	SQL server	Windows 2012 R2 / 8 CPU, 16GB RAM	
	vCenter Server	Windows 2012 R2 / 8 CPU, 16GB RAM	
	View Connection	Windows 2012 R2 / 4 CPU, 10GB RAM	
	View Composer	Windows 2012 R2 / 4 CPU, 8GB RAM	
Login VSI Infrastructure	Login VSI Dataserver	Windows 2012 R2 / (Login VSI 4.1) 4 CPU, 8GB RAM	Intel-based server: Intel Xeon CPU E5-2620 v3 @ 2.40GHz 12 CPUs x 2.399 GHz Memory: 256 GB Network: 2x 1GbE / 2x 10GbE
	Launchers x10	Windows 2012 R2 / 2CPU, 10GB RAM	
Desktop Infrastructure	Parent VM	Windows 10 Office 2010 Login VSI applications	12x Intel-based servers: Intel Xeon CPU E5-2620 v3 @ 2.40GHz 12 CPUs x 2.399 GHz Memory: 256 GB Network: 2x 1GbE / 2x 10GbE
	500x Linked Clone	Same as parent	
Networking	Management	1GbE – 24 ports	3x ZyXEL GS190-24
	Storage Network	10GbE -24 ports	2x DELL N4032
Storage	Main subsystem	QES 1.1 (FreeBSD)/ 2x RAID 6 (2x LUN)	ES1640dc
	Expansion unit (JBOD)	RAID 10 (6x LUNs)	EJ1600



4.4. Important statements for the tested environment

The tested environment has some special configurations that are described as below:

- When designing the test environment, sufficient ESXi hosting resources was given with the intention to prevent bottlenecks from the virtual infrastructure, focusing the test on the backend storage.
- No memory reservation was used, even when the ESXi servers could provide enough memory resources for the 500 desktops. The non-use of memory reservation is to push compression and deduplication performance and demonstrate data reduction capabilities.
- Several tests were run using PCoIP and RDP, both showing similar results for the test. For the test report in this paper, RDP was used for the launchers to initiate all the desktop sessions.
- During desktop deployment and management, the configuration from the View Administrator console for the vCenter operation was left as default (as shown in table 3). The intention was to keep a standard configuration when testing different QNAP storage solutions.

Table 3: Advanced Settings for vCenter Server (Default)

Operation	Limit
Max concurrent vCenter provisioning operations	20
Max concurrent power operations	50
Max concurrent View Composer maintenance operations	12
Max concurrent View Composer provisioning operations	8



5. Test methodology

The test presented in this paper is focused on the storage solution, from its performance and capacity perspective. Various software, tools and monitoring methods were used during the test, which are outlined in this section.

5.1. Test objectives

The main objective of the test was to show the efficiency and capacity of QNAP ES in providing a storage solution for VDI environments.

This objective was achieved by:

- Finding the virtual machine density (maximum user capacity) for the proposed storage solution during the steady-state of a knowledge-worker workload using Login VSI.
- Monitoring the performance during virtual machine deployment and boot storms stage to validate a complete solution including all the VDI workload phases.
- Analyzing capacity reduction techniques that help the storage array to allocate the desktop infrastructure.

5.2. Virtual Machine deployment

The deployment of the virtual machines was carried out using linked clones technology from View Composer (explained in section 4.1.5). From the View Administrator console all the configuration for vCenter was left as default, so only 8 virtual machines are created at the same time.

During the deployment stage, virtual machines were created and the operating systems set up. This stage was monitored by analyzing IOPS, latency and time to complete. This initial configuration for the virtual machines is also known as “the initial boot-storm” and only takes place once. It is often confused with the normal boot-storm workload that happens after the deployment and at beginning of the day during VDI production. The boot storm stage was also monitored, providing a full understanding of VDI behavior during a complete production environment.

Capacity was analyzed by comparing raw capacity, usable capacity before virtual machine



creation, used capacity on the datastores after virtual machine creation, and the final allocated capacity on the QNAP ES.

5.3. Login VSI testing

Login VSI is an industry-standard solution that simulates typical user behavior in centralized virtualized desktop environments. When used for benchmarking, the software measures the total response time of several specific user operations being performed within a desktop workload in a scripted loop.

Login VSI loads the system with simulated user workloads. By gradually increasing the amount of simulated users, the system will eventually be saturated. Once the system is saturated, the response time of the applications will increase significantly. This latency in application response times is a clear indication whether the system is (close to being) overloaded. As a result, by nearly overloading a system it is possible to find out what its true maximum user capacity is.

To set a saturation point (the threshold) the Analyzer first measures a baseline. This number represents the average session response time with minimum load on it. The baseline is calculated by taking the average of the 13 lowest VSI Index Calculations in the entire test. The baseline is the measurement of the response time of specific operations performed in the desktop workload, which is measured in milliseconds (ms).

5.3.1. Workloads

Login VSI 4.1 uses different types of user workload that can be configure for testing scenarios. Every workload consumes different system resources depending on the amount of applications opened in the machine.

Table 4 shows the workload with their average resource consumed, provided by Login VSI. Percentages uses in this table are related to knowledge worker, which was the workload used during the test. The percent is a reference point when comparing the knowledge worker workload with the other workloads. For example office worker workload uses 82% CPU compare to knowledge worker, and so on.



Table 4 Login VSI 4.1 workloads

Workload Name	Apps Open	CPU Usage	Disk Reads	Disk Writes	IOPS	Memory	vCPU
Task Worker	2-7	70%	79%	77%	6	1GB	1vCPU
Office worker	5-8	82%	90%	101%	8,1	1,5GB	1vCPU
Knowledge worker	5-9	100%	100%	100%	8,5	1,5GB	2vCPU
Power worker	8-12	119%	133%	123%	10,8	2GB	2vCPU+

5.3.2. Benchmark mode

Login VSI enables the use of benchmark mode - a restricted test mode. Some settings which are available within the normal mode of Login VSI are now disabled. This is done to create a default test environment in which users can compare test results with each other. If this was not the case, users/vendors could change settings that would benefit their set-up and the test results would be corrupted, and so the comparison would be invalid.

Only two workload types are available in benchmark mode: Office worker and Knowledge worker. The knowledge worker workload was used to stress the system to maximum performance and for testing average user workloads. It is then assumed that the same amount of users will be supported for Task and Office worker workloads.

The knowledge worker workload uses well-known desktop applications such as:

- Microsoft Outlook
- Microsoft Word
- Microsoft Excel
- Microsoft Power Point
- Microsoft Internet Explorer
- Adobe Acrobat
- Doro PDF Writer
- FreeMind
- Photo Viewer



5.3.3. Testing details

The key components for the test and its configuration are detailed in table 5.

Table 5: Testing details

Component	Count	Configuration / Description
Virtual Machines	500	Windows 10, Office 2010 and Login VSI tested applications
Desktop Type	NA	Linked Clone
Workload	NA	Knowledge worker
Desktops hosts	12	ESXi host
Infrastructure hosts	2	For data center, Horizon View and Login VSI infrastructure
Connection server	1	Connection broker
Login VSI dataservers	1	Management console to configure and start the test
Login VSI Launchers	10	Launch remote sessions using RPD
Drive	16	240GB SSD
Storage pool	1	RAID 10 configuration (1.56TB)
Datastores/LUNs	6	Thin provisioning, Compression and Deduplication enabled.
Storage controller	1	Only one controller was used to handle the desktops workload.

5.4. Monitoring tools

Besides Login VSI (Management console and Analyzer), the following tools were used to monitor and obtain specific metrics during the test.

5.4.1. QES Resource Monitor

From the QNAP ES is possible to monitor all the storage resources consumed. The Storage Manager and the Resource Monitor of QES were constantly analyzed to see the backend IOPS on the pool, network bandwidth and storage capacity.

5.4.2. ESXTOP

Running Esxtop in batch mode was effective in gathering all the performance metrics



from the ESXi hosts during the creation, booting and testing of all the virtual machines. IOPS and physical adapter latency on the storage and CPU utilization in the hosts was the Esxtop focus. Esxtop was set to get data every 2 seconds during the iteration periods.

5.4.3. vCenter Performance Monitor

The performance monitor in vSphere Client provides real-time analysis during the test of all the servers in the cluster managed by vCenter. The total CPU and memory consumed was seen to define the amount of servers for the cluster and make sure that no resources bottlenecks were presented.



6. Test results

The test results are detailed in the following sections.

6.1. Login VSI test report

After the test is complete, Login VSI generates an automatic report from its system analyzer. A test overview table is created providing the most important data configured (see table 6).

There are two values in particular that are important to note: VSIbase and VSImax.

1. **VSIbase:** A score reflecting the response time of specific operations performed in the desktop workload when there is little or no stress on the system. A low baseline indicates a better user experience, resulting in applications responding faster in the environment.
2. **VSImax:** The maximum number of desktop sessions attainable on the host before experiencing degradation in user experience. Reaching VSImax is not necessarily required for a test to be considered successful.

Table 6: Login VSI test overview

Testname	500_desktops
VSImax v4	500 Sessions & Baseline 830 ms
Benchmark mode	Enabled
VSI Treshold reached?	NO
VSIbaseline average response time (ms)	830
VSImax average response time threshold (ms)	1830
VSImax threshold was reached at sessions	WAS NOT REACHED
VSI response time threshold headroom	2502
Sessions not responding	0
Corrected VSImax is	500
Total Sessions configured	500
Total Sessions successfully launched	500
Total Timeframe of test in seconds	2880
Average session launch interval in seconds	5.76
Amount of active launchers during test	10
Average session capacity per launcher	50



The test reported an outstanding response time during the activation of all the knowledge-worker workloads. The growth ratio reveals that there is still enough performance for more desktops to be added to the test environment before hitting the VSI_{max} index (system saturation).

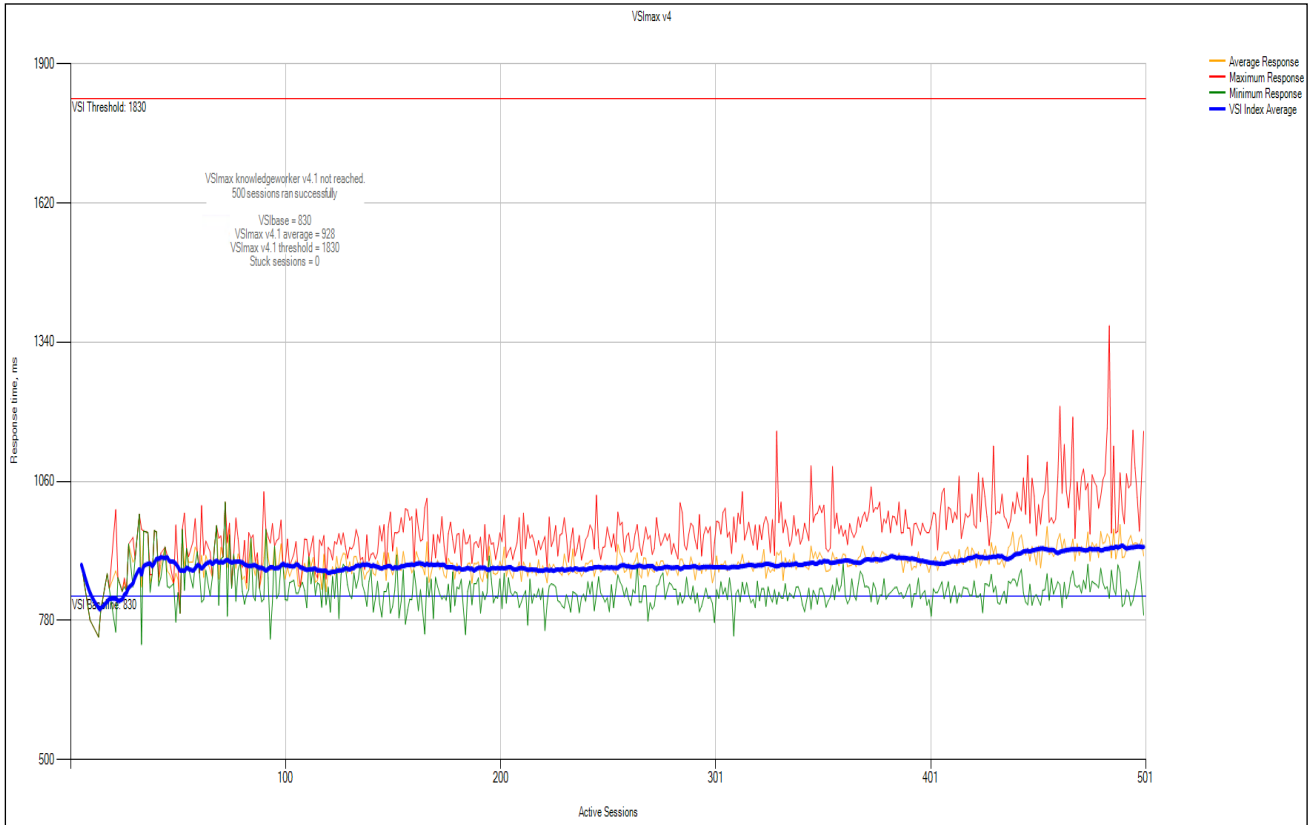

Figure 6: VSI_{max} knowledgeworker v4 - Not reached

The Login VSI_{max} v4 average (score 928) as shown in figure 6. The 500 sessions ran successfully, none of them were stuck during the test.

6.2. Logon, Steady-state and Logoff performance

The Login VSI test also represents the logon, steady-state and logoff of the production cycle of the VDI environment. Using the monitoring tools from QNAP and VMware, information for the consumed resources in the cluster and QNAP ES was analyzed while the test ran; when all the sessions were running at the same time, steady-state data was measured.

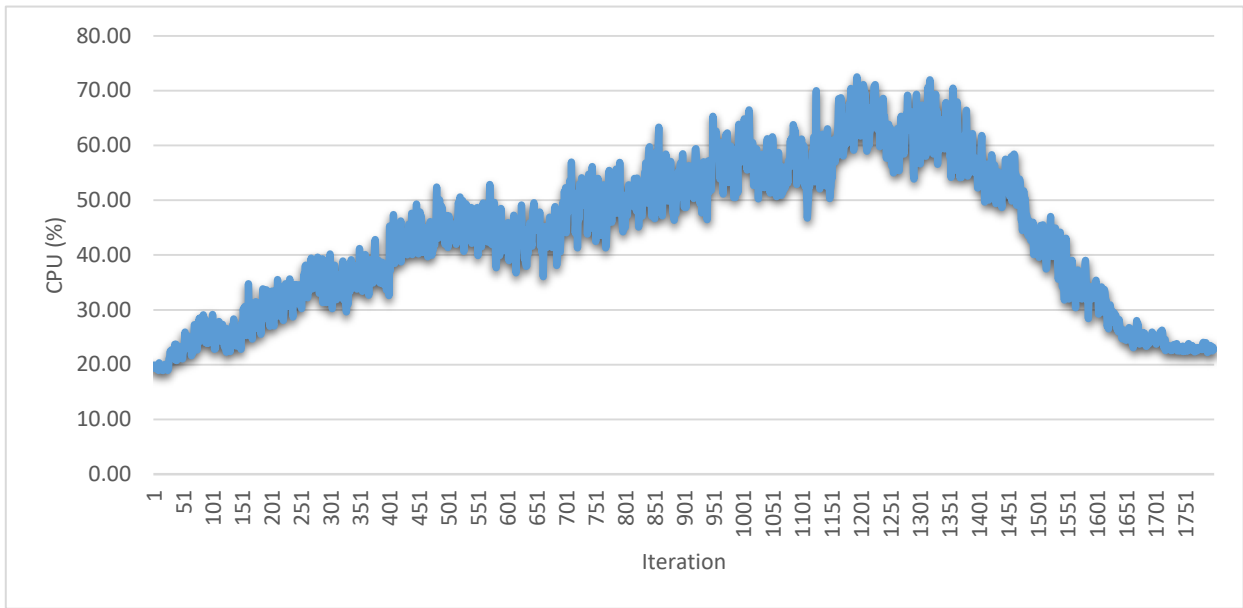

Figure 7: Average CPU utilization per server

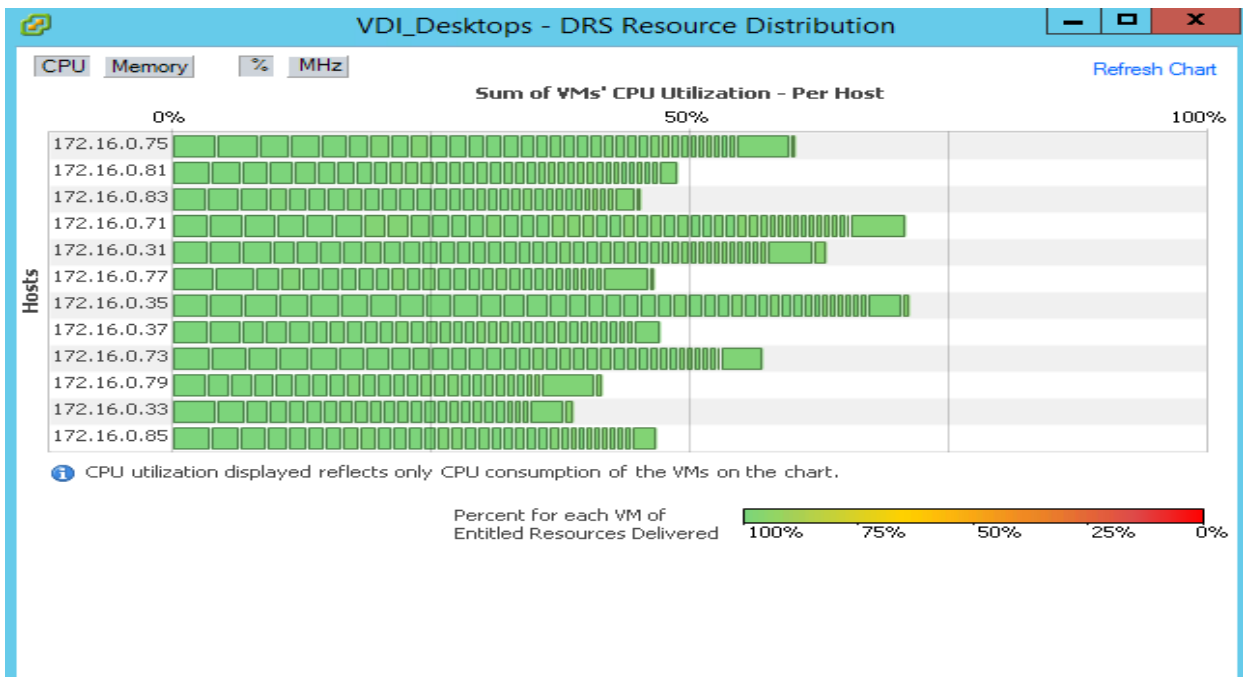

Figure 8: Cluster CPU utilization

Figure 7 indicates the average CPU utilization per server in the cluster. Figure 8 shows the CPU utilization from the vCenter resource distribution chart for the 12 ESXi servers when the 500 sessions were active during the Login VSI test. The average CPU usage during the test was 44%.

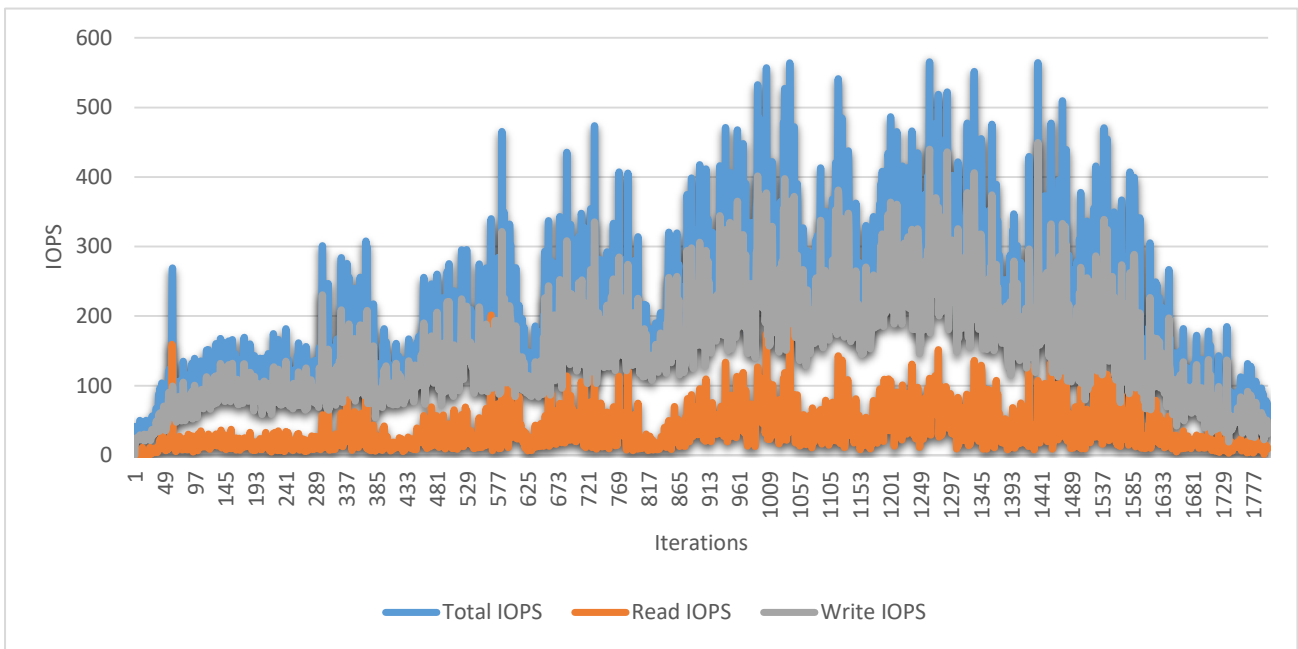

Figure 8: Average IOPS per server

The average IOPS per ESXi server in the disk adapter was 188 IOPS. The whole cluster (12 servers) hit 2,251 IOPS during the testing period (an average of 4.5 IOPS per virtual machine). When all 500 sessions were active (steady-state), the average IOPS was 7.5 per virtual machine. From the figure, the writing operations predominance over the read operation is also indicated.

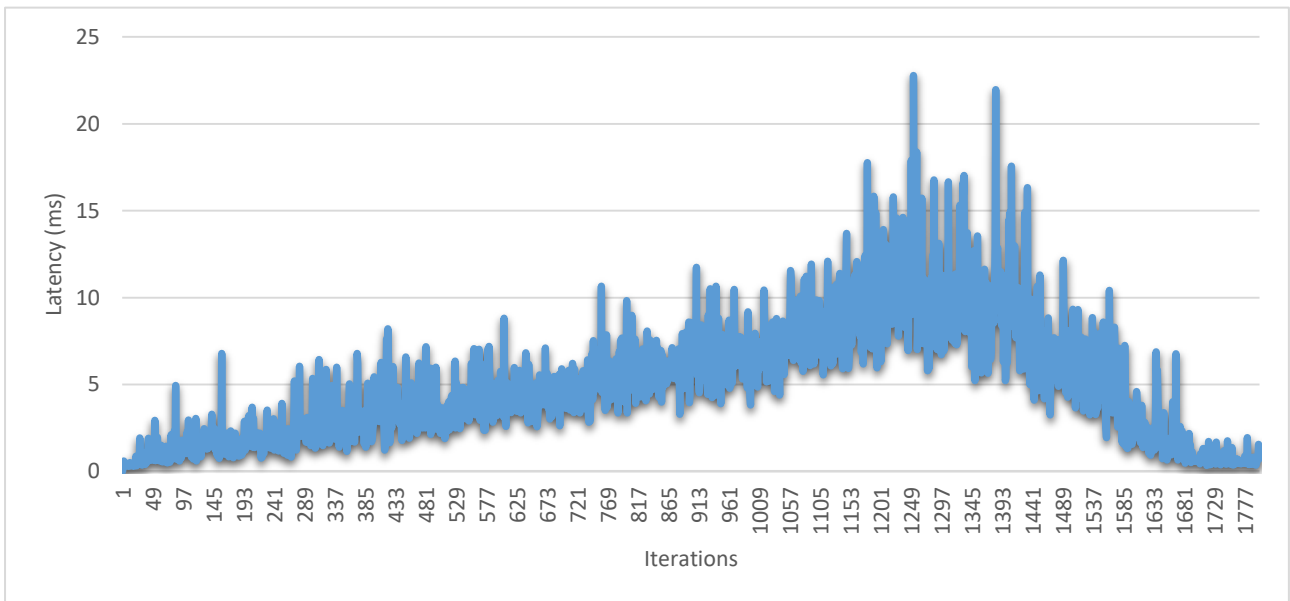

Figure 9: Average disk latency per server

The peak latency barely passed 15ms, with an average latency of 5.5ms during the test. Latencies above 20ms are considered bad performance and it indicates degradation in system performance.

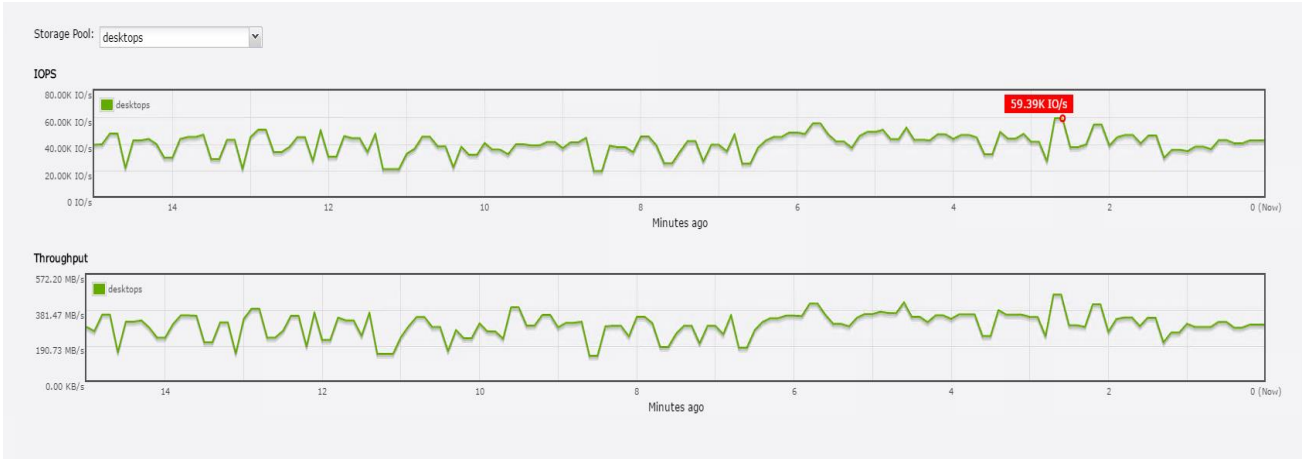

Figure 10: ES Storage IOPS

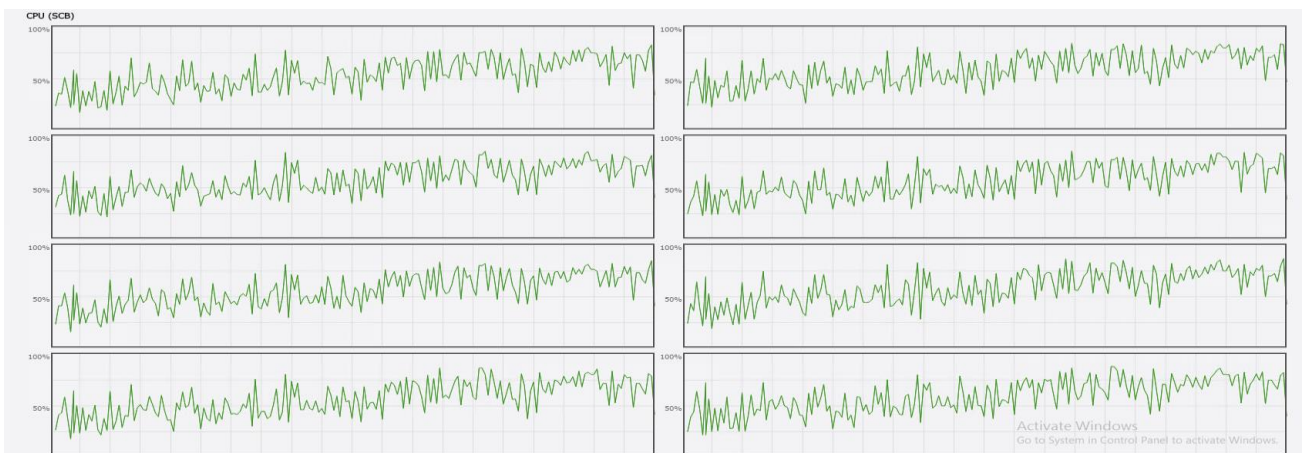

Figure 11: ES Storage CPU

Figures 10 and 11 show that at the moment when all 500 sessions were active, the backend storage observed an average of 40,000 IOPS, and during this peak of IOPS the average controller CPU utilization is under 75% (figure 11 shows 8 out of 12 CPU cores from controller B).

6.3. Deployment and booting performance

Figures 12 to 15 show the average IO performance and average latency per server during the deployment and booting of all 500 virtual machines at the same time.

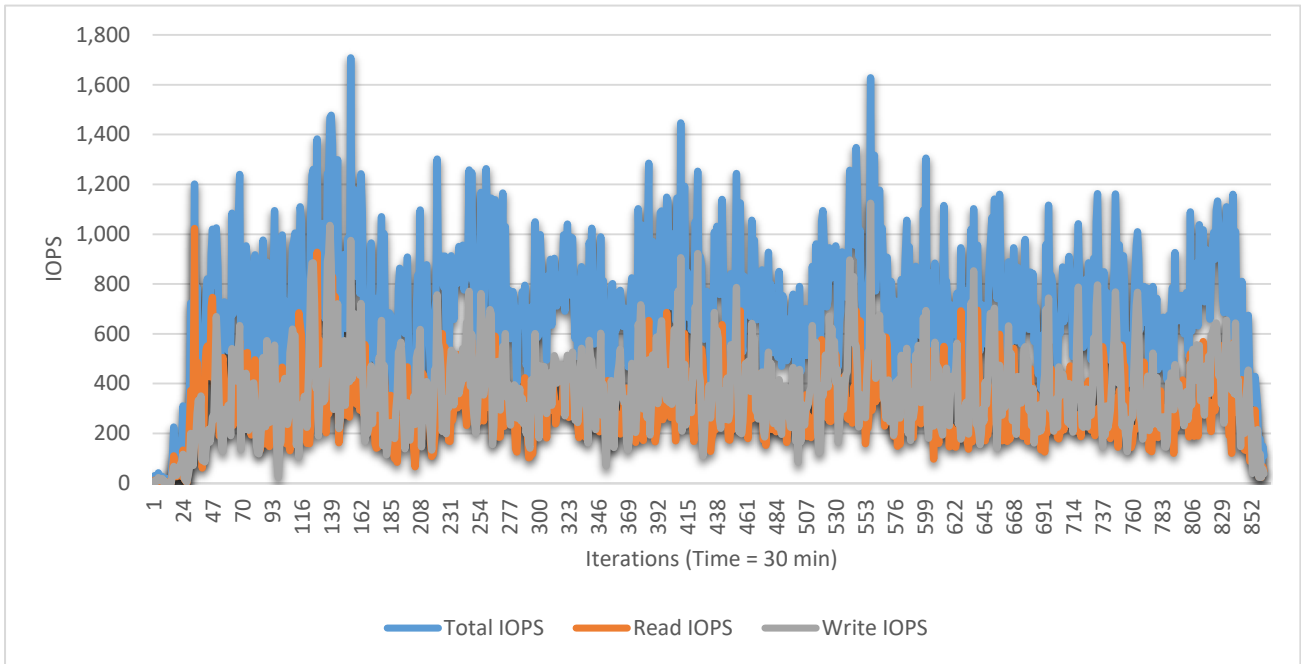

Figure 12: IOPS per server when deploying 500VMs

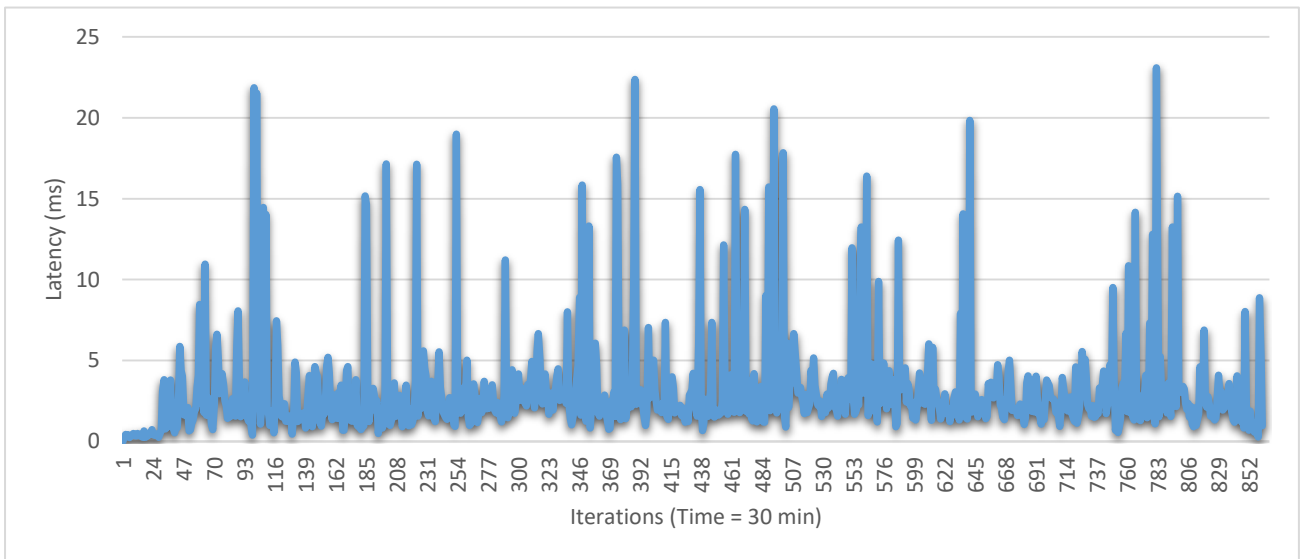

Figure 13: Disk latency per server when deploying 500VMs

The deployment of 500 virtual machines occurred within 30 minutes. The average IOPS registered per server is 674 with the average disk latency of 3ms for the physical adapter. Deployment was boosted by VAAI support on the QNAP ES (which offloads command operations when cloning virtual machines) so fewer IOPS are seen in the ESXi servers during deployment.

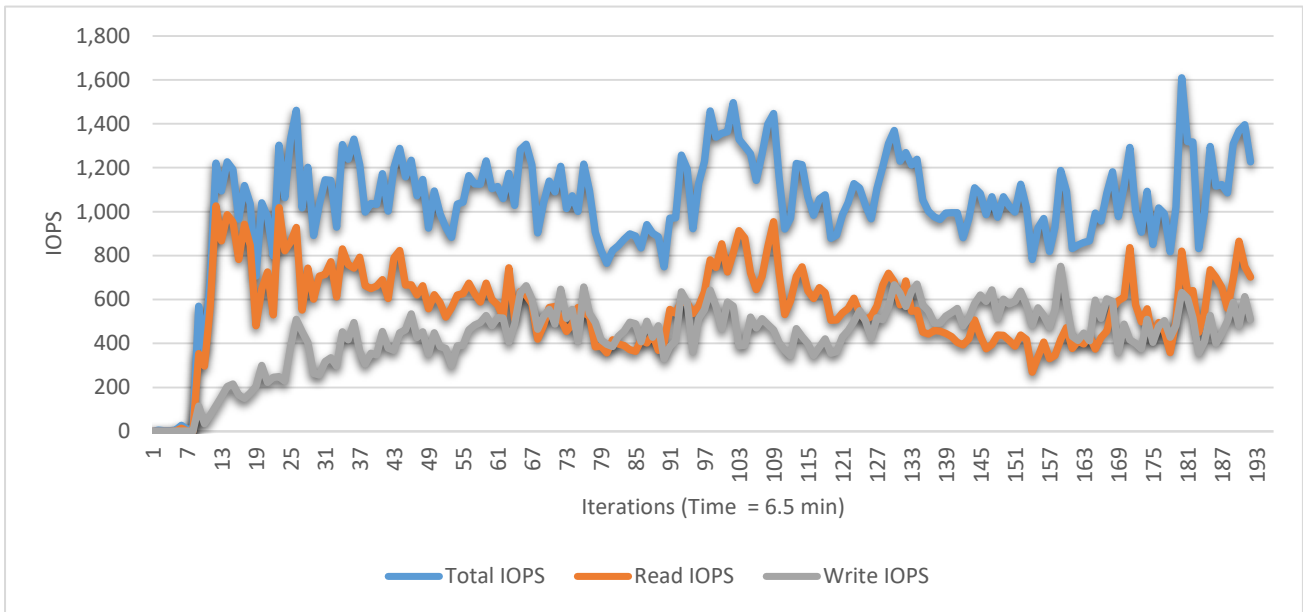

Figure 14: IOPS per server when booting 500VMs

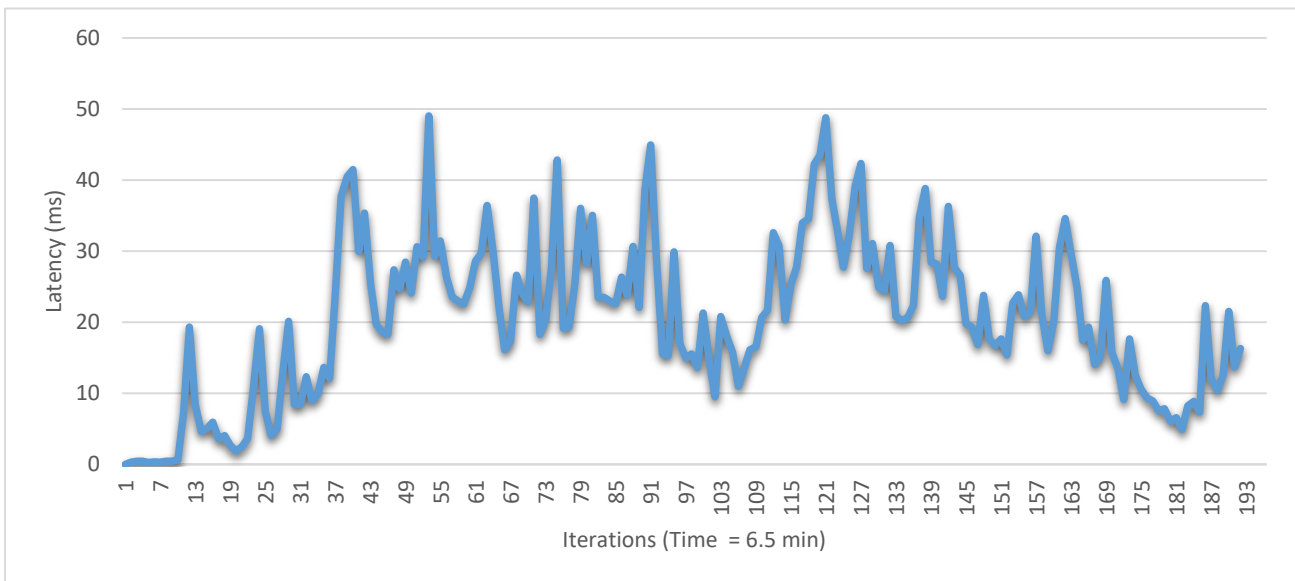

Figure 15: Disk latency per server when booting 500VMs

Several tests for the booting stage were done, reporting an average of 1,000 IOPS per server and 20ms latency from the disk adapter. VAAI also improves the booting performance, allowing the cluster to directly access the virtual disk by unlocking the datastores for all the servers accessing at the same time. All 500 VMs were booted in less than 7 minutes.



Table 7 and figures 16 and 17 compares the whole VDI production cycle for the deployment, booting, and the testing of the virtual machines and provides valuable data of IO patterns during the VDI stages. This data is vital for designing and sizing the storage performance solution with QNAP ES. The data presented is for the 12 servers in the cluster.

Table 7: VDI Production cycle for the desktop infrastructure.

Operation (stage)	IOPS	Write percent	Read percent	Latency	Time
Deploying	8,084	55%	45%	3 ms	30 min
Booting	12,000	44%	56%	20 ms	6.5 min
Login VSI test	2,551	89%	19%	5.5 ms	60 min

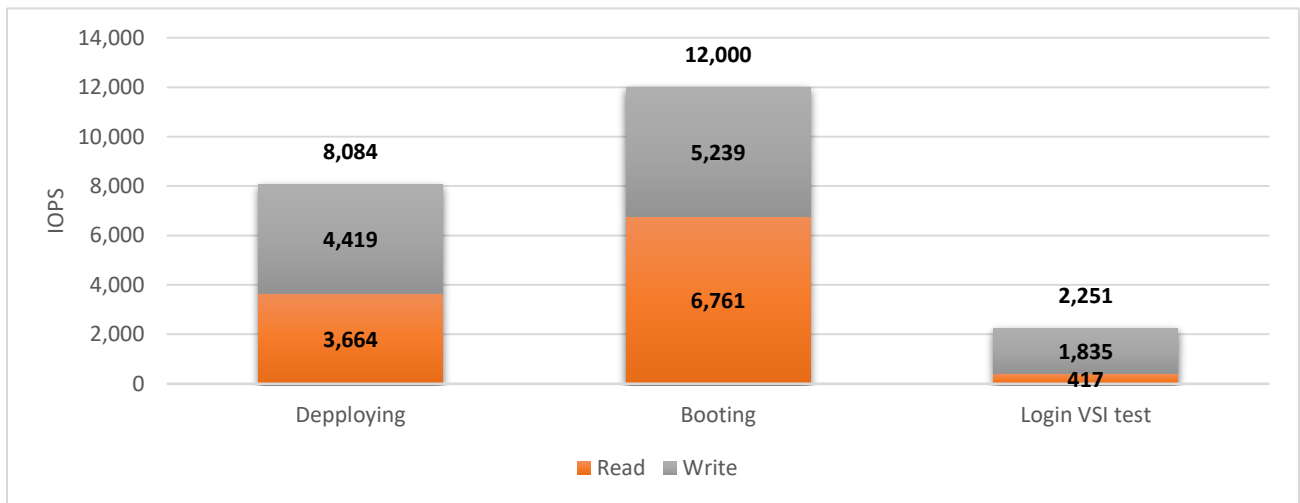

Figure 16: IOPS (cluster) - VDI production cycle

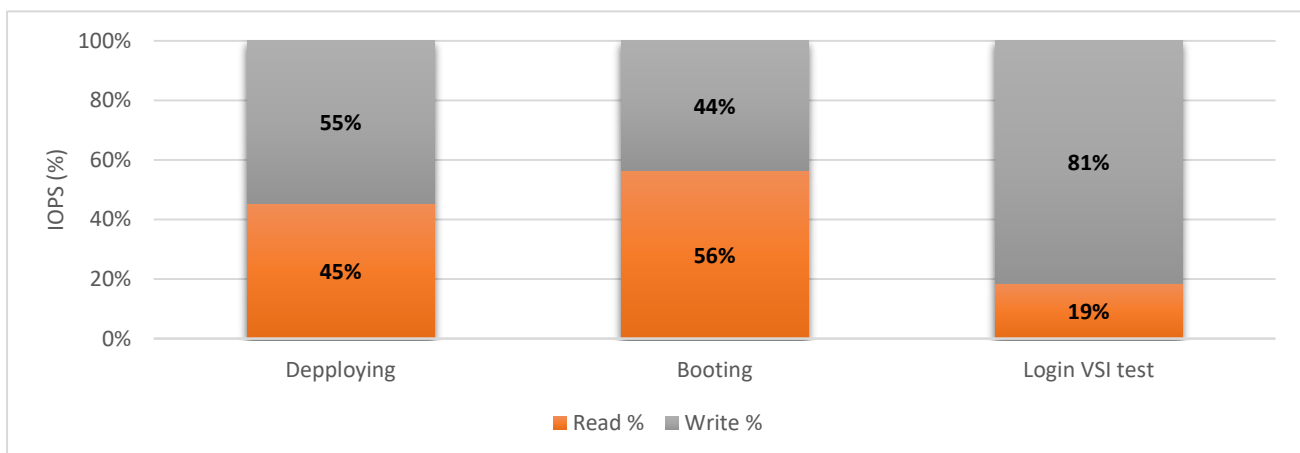

Figure 17: IOPS % ratio (cluster) - VDI production cycle

6.4. Storage capacity reduction

The results of the capacity allocated during the test and techniques used to achieve it are detailed in this section. The analysis of the storage capacity on the QES system shows the storage pool allocated capacity, before and after deploying (and booting) the 500 virtual machines. Only 290GB are presented in the storage pool.

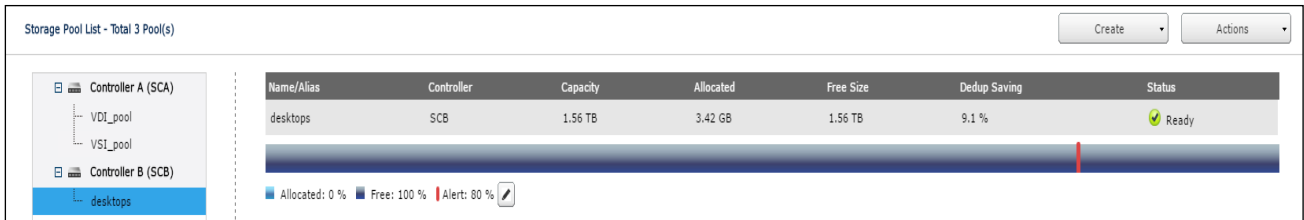

Figure 18: Allocated capacity before virtual machine deployment

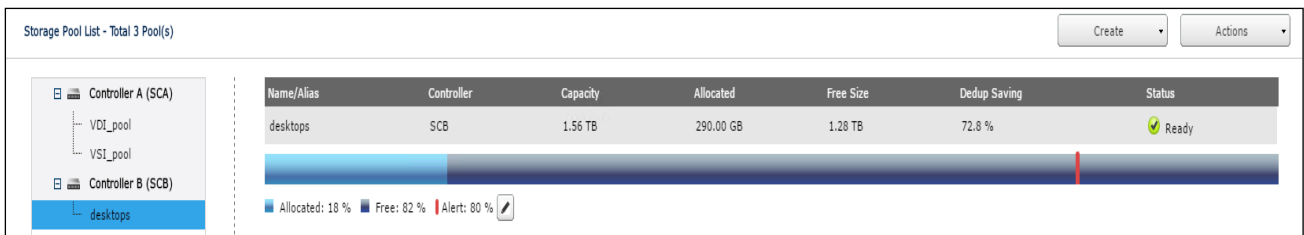

Figure 19: Allocated capacity after virtual machine deployment

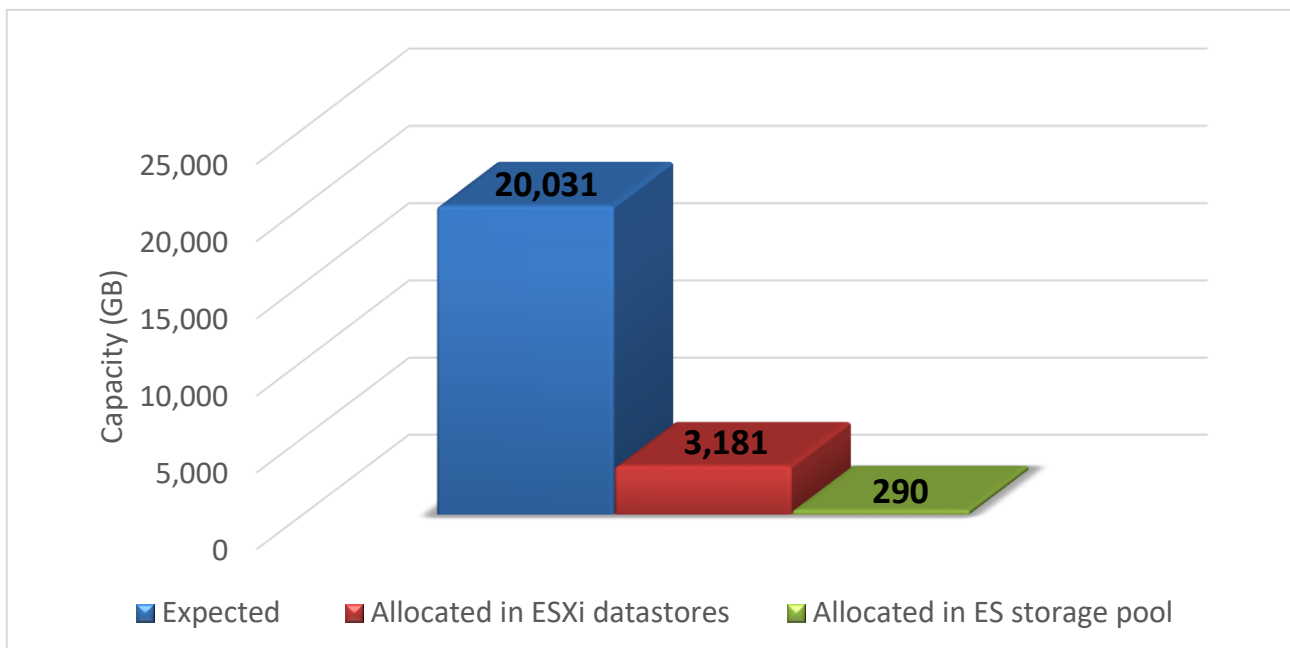

Figure 20: Allocated capacity comparison



Figure 20 shows the capacity distributed during the design and deployment for the VDI solution. It compares the expected capacity to be used against the capacity allocated in datastores and the storage pool.

The storage usage is drastically reduced because of the use of linked clones by VMware, and the QNAP ES system's compression and deduplication. The capacity is distributed as follows:

- **Expected capacity to be used:** If normal clones are used (full clones) instead of linked clones the capacity consumed will be approximately 20,031GB
- **Allocated capacity in ESXi datastores:** After linked clones are deployed by Horizon View Composer, the capacity consumed in the datastores is 3,181GB. This represents an 84% capacity reduction from the original expected capacity for the virtual machines.
- **Allocated capacity in QNAP ES storage pool:** After using compression and deduplication in the QNAP ES, the capacity allocated in the datastore is only 290GB, this represents an extra 91% capacity reduction from the capacity allocated in the ESXi datastores by the linked clones.

Combining the linked clones and the reduction techniques from the QNAP ES, the total capacity actually used by the system is 1.4% of the expected 20,031GB (100%).

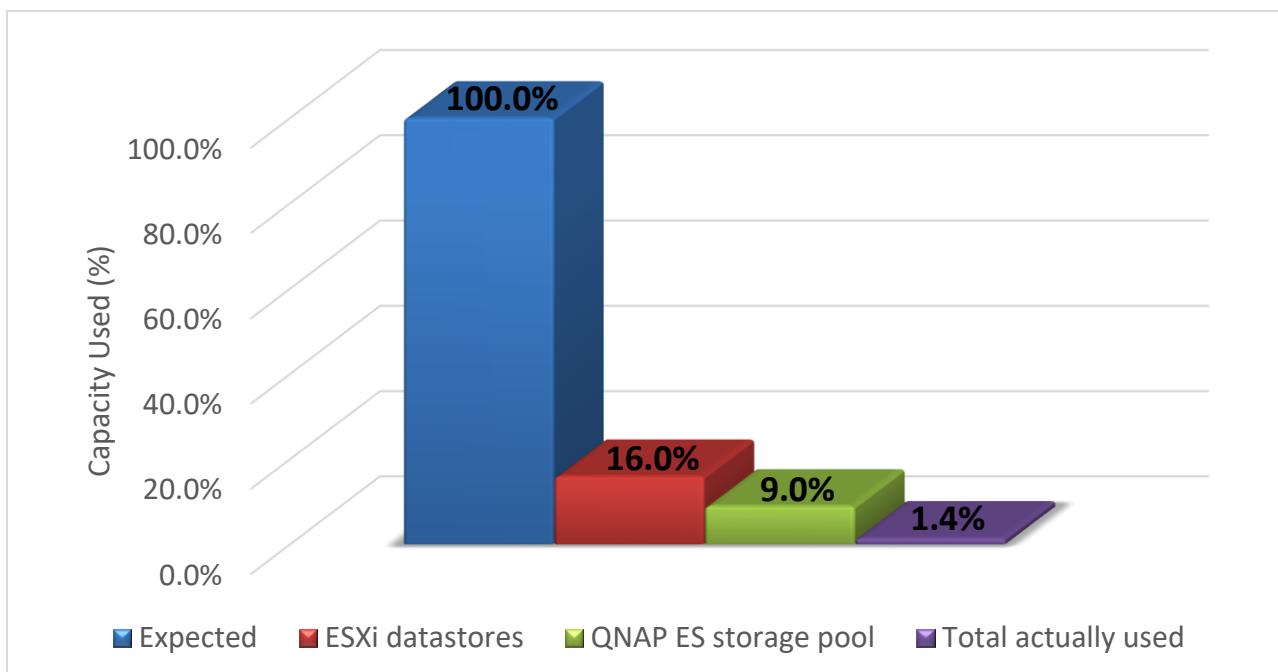

Figure 21: Used capacity after reduction techniques



7. Conclusion

The primary objective for the tested architecture presented in this paper is to validate the efficiency and performance of the QNAP ES1640dc in the deployment and production environments for VDI. An impressive desktop density of 500 VMs was achieved by a single storage enclosure filled with SSDs and managed by a single storage controller. By using both controllers the performance will be boosted allowing over 1,000 desktops in a single QNAP storage array.

Utilizing QNAP ES1640dc with VMware Horizon View infrastructures dramatically increased the desktop density without compromising the user experience. Leveraging its user-friendly management interface, the reduction techniques for data-warehousing and the stunning performance from demanding IO workloads, QNAP Enterprise Storage is the best partner for IT staff and storage administrators when choosing a cost-effective solutions for VDI deployment.



About QNAP

QNAP Systems, Inc., as its brand promise "Quality Network Appliance Provider", aims to deliver comprehensive offerings of cutting edge network attached storage (NAS) and network video recorder (NVR) solutions featured with ease-of-use, robust operation, large storage capacity, and trustworthy reliability. QNAP integrates technologies and designs to bring forth quality products that effectively improve business efficiency on file sharing, virtualization applications, storage management and surveillance in the business environments, as well as enrich entertainment life for home users with the offering of a fun multimedia center experience. Headquartered in Taipei, QNAP delivers its solutions to the global market with nonstop innovation and passion.

For more information about QNAP visit: www.qnap.com

About VMware

VMware is a global leader in cloud infrastructure and business mobility. VMware accelerates customers' digital transformation journey by enabling enterprises to master a software-defined approach to business and IT. With VMware solutions, organizations are creating exceptional experiences by mobilizing everything, responding faster to opportunities with modern data and apps hosted across hybrid clouds, and safeguarding customer trust with a defense-in-depth approach to cybersecurity

For more information about VMware visit: www.vmware.com

About Login VSI

Login VSI provides performance insights for virtualized desktop and server environments. Enterprise IT departments use Login VSI products in all phases of VDI operations management (VDIops)—from planning to deployment to change management—for more predictable performance, higher availability and a more consistent end user experience. The world's leading virtualization vendors use the flagship product, Login VSI, to benchmark performance. With minimal configuration, Login VSI products works in VMware Horizon, Citrix XenDesktop and XenApp, Microsoft Remote Desktop Services (Terminal Services) and any other Windows-based virtual desktop solution. Visit <http://www.loginvsi.com> for more information.